

Product Catalogue



GLASS & ALUMINIUM
SPECIALISTS



Premium solutions for contemporary spaces

A refined range of products designed to balance performance, clarity, and architectural elegance.

Our experienced glaziers bring precision, care, and reliability to every project.

With a strong focus on quality workmanship and attention to detail, they ensure each installation is finished to a high standard and built to last.

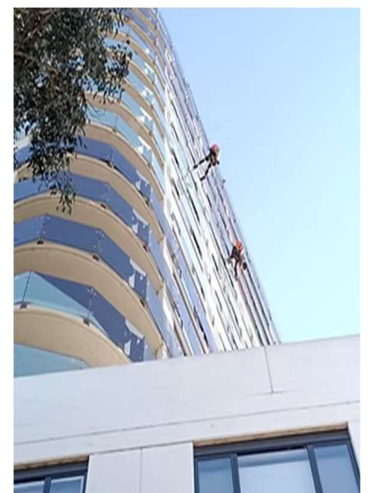
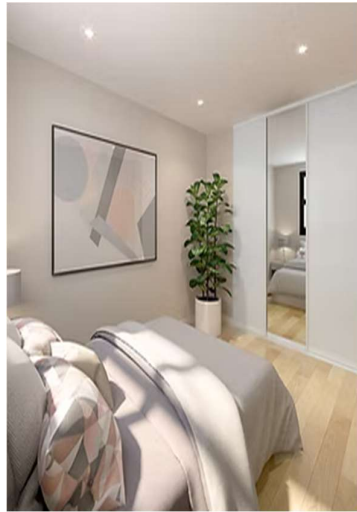

Product Index

3	Full Framed Shower Screens
4,5	Semi-Frameless Shower Screens
6	Frameless Shower Screens
7,8	Sliding Wardrobe Doors
9	Wall Hung Mirrors
10	Fly Screens & Security Screens
11,12,13	Pet Doors
14	Glass Splashbacks
15	Energy Glass Upgrades
16	Commercial Windows & Doors

Full Framed Shower Screens



DIMENSION - FULL FRAMED

Full framed built for durability.

Why customers choose it:

Great protection in the case of an accident

Reliable hardware and seals for constant use

features a door drip gutter to prevent drips when exiting.

Flexible configuration options for unique spaces

Typical configurations:

- Traditional two sides
- Three-side corner
- Straight line
- Stepped dogleg

Sill-less entry option available

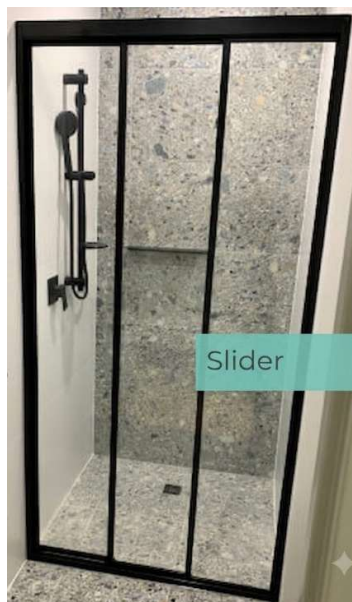

SLIDING - FULL FRAMED

Full framed built for durability.

Why customers choose it:

Great protection in the case of an accident

Smooth adjustable rollers

No swinging doors allowing drips outside shower

Flexible configuration options for unique spaces

Typical configurations:

- Traditional two sides
- Straight line
- Stepped dogleg



MAINE - FULL FRAMED

Versatile framed panels ideal for custom enclosures, replacements, and tailored bathroom layouts.

Adaptable panel system for a wide range of applications

Durable framed construction for everyday reliability

A practical, cost-effective solution with a elegant finish

Easy to integrate into existing or new bathrooms

Sill-less entry

Typical configurations:

- Rectangular Fluted Glass
- Rectangular Clear Glass
- 500mm Radius Curved Fluted Glass

Semi-Frameless Shower Screens



OPTIMA - SEMI-FRAMELESS

Semi-frameless style with a crisp, contemporary finish.

Why customers choose it:

- Clean, modern styling that suits most bathrooms
- Excellent water containment with a discreet frame
- Quality toughened glass for everyday durability
- Simple to install, maintain, and keep looking new
- Minimum standard height 1850mm tall

Typical configurations:

- Straight line
- Traditional two-side setting

Sill-less entry option available



EVOLUTION - SEMI-FRAMELESS

Semi-frameless solution with strong support and a refined profile.

Why customers choose it:

- Elegant slim framing for a premium bathroom finish
- Reliable hinge hardware designed for smooth daily use
- Easy-clean surfaces for low-maintenance appeal
- Flexible configuration options for unique spaces

Typical configurations:

- Traditional two sides
- Three-side corner
- Straight line
- Stepped dogleg

Sill-less entry option available

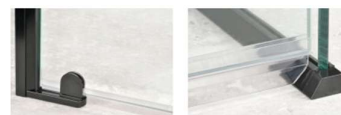

Semi-Frameless Shower Screens



MOMENTUM - SEMI- FRAMELESS

Space-saving semi-frameless sliding shower screen.

Why customers choose it:

Smooth, quiet sliding action for comfortable daily use

Ideal for bathrooms where space matters most

Premium components built for durability and longevity

Clean lines that bring a more modern, high-end look

Typical configurations:

Traditional two sides

Straight line

Stepped dogleg

Sill-less entry option available



SLYDER - SEMI-FRAMELESS

Why customers choose it:

Smooth, quiet sliding action for comfortable daily use

Ideal for bathrooms where accessibility is the focus

Minimalistic design, making it easy to clean

Clean lines that bring a more modern, high-end look

Permanent sill-less entry

Typical configurations:

Traditional two sides

Straight line

Frameless Shower Screens

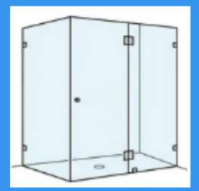

FIXED PANEL FRAMELESS

Space-saving semi-frameless sliding shower screen.

Why customers choose it:

Smooth, quiet sliding action for comfortable daily use

Ideal for bathrooms where accessibility is the focus

Minimalistic design, making it easy to clean

Clean lines that bring a more modern, high-end look

Permanent sill-less entry

Typical configurations:

- Straight line
- Two sides



MANHATTAN - FRAMELESS

Space-saving semi-frameless sliding shower screen.

Why customers choose it:

Smooth, quiet sliding action for comfortable daily use

Ideal for bathrooms where accessibility is the focus

Minimalistic design, making it easy to clean

Clean lines that bring a more modern, high-end look

Permanent sill-less entry

Typical configurations:

Traditional two sides

- Straight line
- Traditional two sides



HINGED - FRAMELESS

Space-saving semi-frameless sliding shower screen.

Why customers choose it:

Smooth, quiet sliding action for comfortable daily use

Ideal for bathrooms where accessibility is the focus

Minimalistic design, making it easy to clean

Clean lines that bring a more modern, high-end look

Permanent sill-less entry

Typical configurations:

- Traditional two sides
- Straight line

Sliding Wardrobe Doors

MIRROR GLASS, PAINTED GLASS, TIMBER PANELING



ESTATE

Tracking wheels made from hard wearing nylon mounted on a ball bearing axle.

Door weights up to 50kgs can be achieved

Systems run on large Ø42mm convex nylon ball bearing rollers for quiet operation

Open designed roller allows for ease of cleaning and a reduction in dust accumulation

Easily adjust doors with the height setting mechanism integrated into the roller's steel chassis

Configurations:

- 6 Panels
- 4 Panels
- 3 Panels
- 2 Panels

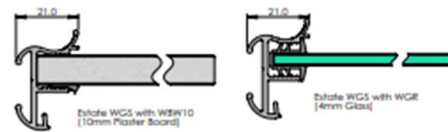

FLEXIBLE INFILL PANELS



HARD WEARING ROLLERS



ADJUSTMENT MECHANISM



RESIST DUST BUILD-UP



ION

Triple head and sill measuring 79mm wide allows the install three doors in the footprint of a standard double-door

Double head and sill measuring 53mm wide affords the smallest possible wardrobe footprint

Timeless design to compliment most decor

Rollers fully housed in bottom rail

Easy operation and added door strength due to continuous finger vertical grip

Smooth & quiet to use with 42mm diameter rollers

Configurations:

- 6 Panels
- 4 Panels
- 3 Panels
- 2 Panels



FLEXIBLE INFILL PANELS



HARD WEARING ROLLERS



ADJUSTMENT MECHANISM

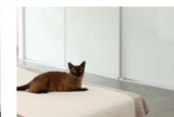

RESIST DUST BUILD-UP

Wall Hung Mirrors

FULL FRAMED, SEMI FRAMED, FRAMELESS

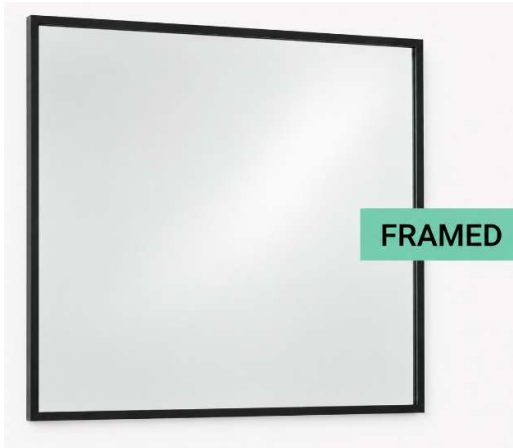

FULL FRAMED

Finishes are made to withstand the rigours of the bathroom to ensure years of beautiful use.

Strong and protective edging to prevent those accidental knocks.

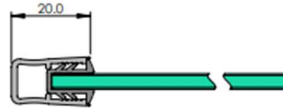

CONCEALED FRAME

Finishes are made to withstand the rigours of the bathroom to ensure years of beautiful use.

Protective edge with the appearance of frameless

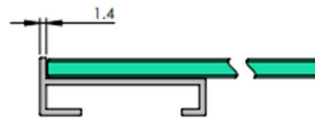

FRAMELESS

Smooth polished edges

Sleek fine finish against the wall



Security Screens & Fly Screens

STAINLESS STEEL, PERFORATED, DIAMOND GRILLE, PET PROOF MESH



WINDOW & DOOR INSECT SCREENS

Plenty of colours available all standard & non-standard powder coating colours including anodised.

Window screens available in 9mm & 11mm to suit most window tolerances.

Soft mesh types available

- Fibreglass Mesh
- Aluminium Mesh
- Pet Mesh

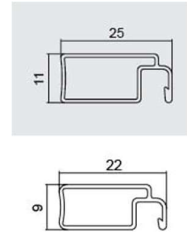

DIAMOND GRILLE BARRIER SCREEN

The cost-effective classic for reliable home protection.

Reliable Security: Features a robust aluminium frame and a classic diamond grille design, providing a solid physical deterrent against intruders.

Enhanced Ventilation: Allows fresh air to flow freely throughout your home while maintaining a secure barrier.

Budget-Friendly: An excellent, cost-effective solution for those seeking security without compromising on essential functionality.

Customizable: Available in a wide array of powder-coated finishes to seamlessly match your existing home aesthetic.

Single point lock as standard



Security Screens & Fly Screens

STAINLESS STEEL, PERFORATED, DIAMOND GRILLE, PET PROOF MESH



PERFORATED BARRIER SCREEN

A modern, sleek aesthetic with superior privacy and airflow.

Contemporary Design: Features an aluminium sheet with precision-punched holes, offering a clean, modern look that complements contemporary architecture.

Excellent Privacy: The unique perforated pattern restricts the view into your home from the outside, providing enhanced privacy during the day.

High-Level Airflow: Engineered to maximize ventilation while maintaining a strong, corrosion-resistant insect screen barrier.

3 Point triple lock as standard



DEFENDOR SECURITY SCREEN

Maximum strength, maximum visibility, peace of mind.

Uncompromising Strength: Constructed with a high-tensile 316 marine-grade stainless steel mesh, offering industry-leading resistance to cutting and impact.

Crystal Clear Views: The fine mesh design provides high transparency, ensuring your view of the outdoors remains uninterrupted and clear.

Maximum Security: Exceeds Australian Standards for security, providing the ultimate protection for your family and assets.

Low Maintenance: The powder-coated stainless-steel mesh is exceptionally durable and requires minimal maintenance to keep it looking brand new.

3 Point triple lock as standard



Pet Door Installations

SMALL, MEDIUM, LARGE, EXTRA LARGE



SMALL ROUND

Available in: Clear Only

Glass Cut-Out Size: 267mm diameter

Flap Size: 195mm x 185mm

External Frame Size: 304mm

Diameter Frame Protrusion: Internal 10mm / External 10mm (requiring 10mm clearance for sliding door compatibility)

Durable Construction: Flap made from high-impact, polycarbonate for lasting use.

4-Way Locking & Magnetic Seal: Lock the flap for security or use powerful magnets to re-align the seals after use.

Weather Protection: Brush seal minimises drafts and keeps dust out, ensuring comfort indoors.

Best Suited for Cats & Small Dogs: Smaller Maltese Shih Tzu, Miniature Dachshunds, Toy and Teacup breeds.



SMALL RECTANGLE

Available in: Black or White

Glass Central Cut-Out Size: 295mm (H) x 225mm (W)

Flap Size: 240mm (H) x 175mm (W)

External Frame Size: 335mm (H) x 263mm (W)

Frame Protrusion: Internal 8mm / External 8mm (requiring 7mm clearance for sliding door compatibility)

Recommended Pet Shoulder Height: Up to 330mm **Durable Construction:** Flap made from high-impact, polycarbonate for lasting use.

2-Way Locking & Magnetic Seal: Lock the flap for security or use powerful magnets to re-align the seals after use.

Weather Protection: Brush seal minimises drafts and keeps dust out, ensuring comfort indoors.

Easy Installation & Maintenance: Removable flap simplifies training for new pets and makes cleaning hassle-free.

Best Suited for Cats & Small Dogs: Smaller Maltese Shih Tzu, Miniature Dachshunds, Toy and Teacup breeds

Pet Door Installations

SMALL, MEDIUM, LARGE, EXTRA LARGE



MEDIUM ROUND

Available in: Clear Only Glass Cut-Out Size: 320mm

Flap Size: 240mm x 215mm

External Frame Size: 340mm x 340mm

Frame Protrusion: Internal 10mm / External 10mm (requiring 10mm clearance for sliding door compatibility)

Durable Construction: Flap made from high-impact, polycarbonate for lasting use.

4-Way Locking & Magnetic Seal: Lock the flap for security or use powerful magnets to re-align the seals after use.

Weather Protection: Brush seal minimises drafts and keeps dust out, ensuring comfort indoors.

Best Suited For: Intermediate dogs up to 14kgs.



MEDIUM RECTANGLE

Available in: Black or White

Glass Central Cut-Out Size: 350mm (H) x 270mm (W)

Flap Size: 290mm (H) x 225mm (W)

External Frame Size: 390mm (H) x 315mm (W)

Frame Protrusion: Internal 8mm / External 8mm (requiring 7mm clearance for sliding door compatibility)

Recommended Pet Shoulder Height: Up to 460mm

Durable Construction: Flap made from high-impact, polycarbonate for lasting use.

2-Way Locking & Magnetic Seal: Lock the flap for security or use powerful magnets to re-align the seals after use.

Weather Protection: Brush seal minimises drafts and keeps dust out, ensuring comfort indoors.

Easy Installation & Maintenance: Removable flap simplifies training for new pets and makes cleaning hassle-free.

Best Suited For: Cavoodles/Moodles, Smaller Staffies, Maltese Shitzu, Boston Terrier, West Highland Terrier

Pet Door Installations

SMALL, MEDIUM, LARGE, EXTRA LARGE



LARGE ROUND

Available in: Clear Only Glass Cut-Out Size: 385mm

Flap Size: 300mm x 270mm

External Frame Size: 430mm x 415mm

Frame Protrusion: Internal 10mm / External 10mm (requiring 10mm clearance for sliding door compatibility)

Durable Construction: Flap made from high-impact, polycarbonate for lasting use.

4-Way Locking & Magnetic Seal: Lock the flap for security or use powerful magnets to re-align the seals after use.

Weather Protection: Brush seal minimises drafts and keeps dust out, ensuring comfort indoors.

Best Suited For: Medium to semi-large dogs up to 20kg



LARGE RECTANGLE

Available in: Black or White

Glass Central Cut-Out Size: 475mm (H) x 340mm (W)
Flap Size: 425mm (H) x 295mm (W)

External Frame Size: 520mm (H) x 385mm (W)

Frame Protrusion: Internal 8mm / External 8mm (requiring 7mm clearance for sliding door compatibility)

Recommended Pet Shoulder Height: Up to 550mm approx.

Durable Construction: Flap made from high-impact, polycarbonate for lasting use.

2-Way Locking & Magnetic Seal: Lock the flap for security or use powerful magnets to re-align the seals after use.

Weather Protection: Brush seal minimises drafts and keeps dust out, ensuring comfort indoors.

Easy Installation & Maintenance: Removable flap simplifies training for new pets and makes cleaning hassle-free.

Best Suited For: Large Staffies, British Bulldogs, Golden Retrievers, German Shepards, Labradors, Collies, Boxers.

GLASS SPLASHBACKS

PAINTED ULTRA CLEAR GLASS, MIRROR TOUGHENED GLASS

MIRROR GLASS

Brighten up your kitchen and make it feel much more spacious

- Silver Toned
- Grey Toned
- Bronze Toned



PAINTED ULTRA CLEAR GLASS

Pristine Colour Accuracy:

Unlike standard glass which has a natural green tint, our **ultra-clear, low-iron glass** ensures your chosen paint colour remains true, vibrant, and undistorted.

Exceptional Durability:

This 6mm glass is **toughened and heat-strengthened**, providing superior resistance to the high temperatures generated by stovetops, as well as exceptional impact resistance for daily kitchen wear.

Seamless Hygiene:

The smooth, non-porous surface is incredibly easy to wipe clean, and because it is a single sheet, there are **no grout lines** to trap grease, food particles, or bacteria.

ENERGY GLASS UPGRADES

ACOUSTIC GLASS, UV PROTECTIVE GLASS, INSULATING DOUBLE GLAZING

ENERGY SINGLE GLAZED

Thermal Efficiency: Advanced coatings minimize heat gain in summer and heat loss in winter, keeping your internal temperature more consistent.

Cost-Effective Upgrade: An affordable way to improve your home's energy rating by utilizing your current window frames.

UV Protection: Significantly reduces the transmission of harmful UV rays, protecting your furniture, flooring, and artwork from fading.

Glare Reduction: Softens harsh sunlight, creating a more comfortable and glare-free living environment.



ENERGY TECH LAMINATED SAFETY

Advanced Safety & Security: The strong interlayer prevents the glass from shattering upon impact, acting as a powerful deterrent against break-ins.

Energy-Efficient Performance: Integrated technology works to block heat transfer, helping you maintain a stable indoor climate year-round.

Acoustic Insulation: The interlayer provides excellent noise reduction, effectively dampening external sounds from traffic, wind, or neighbours.

Total UV Block: Filters out damaging UV rays, offering the highest level of protection for your interior finishes.

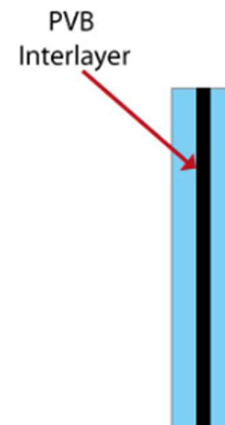

INSULATING DOUBLE GLAZING

Superior Thermal Insulation: The sealed air or gas-filled space between two panes of glass acts as a powerful insulator, drastically reducing energy bills.

Maximum Noise Reduction: The dual-pane system creates an exceptional acoustic barrier, ensuring a quiet, peaceful home environment.

Elimination of Condensation: Reduces the occurrence of internal condensation on windows, promoting a healthier home and preventing potential mould growth.

Year-Round Comfort: Maintains the perfect indoor environment regardless of the season, providing cooler interiors in summer and warmer spaces in winter.

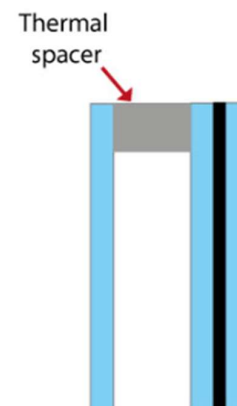

COMMERCIAL WINDOWS & DOORS

HINGED DOORS, SLIDING DOORS, FIXED WINDOWS, AWNING WINDOWS

50mm-100MM

SINGLE- & DOUBLE-GLAZED WINDOW

- Glass thickness from 6mm - 30mm
- Self-draining transom
- Range of sub head and sub sill options
- Available in in standard & non-standard powder coating colours

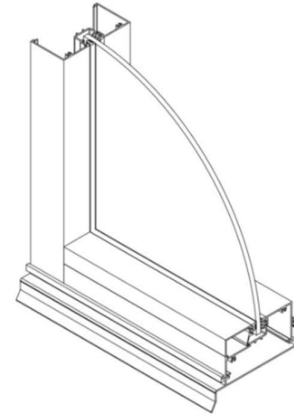

150MM - 250mm

SINGLE- & DOUBLE-GLAZED WINDOW

- Ideal for higher wind loading areas
- Glass thickness from 6mm - 30mm
- Self-draining transom
- Range of sub head and sub sill options
- Range of heavy-duty mullion options for tall framing and high wind areas
- Available in in standard & non-standard powder coating colours

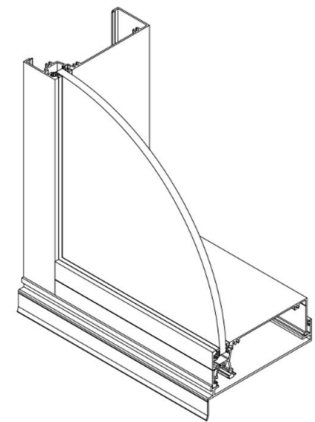

35MM & 45MM HINGED DOOR

- Glass thickness from 6mm - 30mm
- large heavy-duty stiles available
- High quality wrap around hinges
- High quality external fitted slide bolt locks
- Quality reliable tested locking hardware
- Range of handle options available
- Available in in standard & non-standard powder coating colours

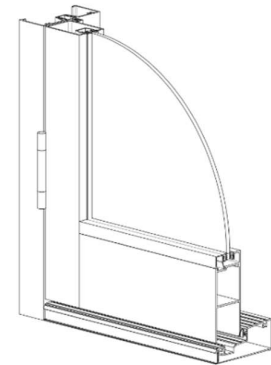

35mm & 45mm SLIDING DOOR

- Glass thickness from 6mm - 30mm
- High quality sliding rollers designed for heavy weight
- Available in in standard & non-standard powder coating colours
- Quality reliable tested locking hardware
- Range of handle options available
- Available in in standard & non-standard powder coating colours

